

ALYCE MODULE

Zhaga Standard LED Module



comply with



EUROPEAN
COMMISSION



Zhaga

ALYCE MODULE

Zhaga Standard LED Module

ALYCE MODULE is a future trend design for luminaires by offering features of standardization, modularization, sustainability. It was designed according to Zhaga standard on mechanical, photometric, electrical, thermal, control interface.

The Zhaga Consortium is a global lighting-industry organization that aims to standardize components of LED luminaires, including LED light engines, LED modules, LED arrays, holders, electronic control gear (LED drivers) and connectivity fit systems. Alyce module opens up a wide range in the luminaires design for panel light, pendant light, recessed light, floor light, track light etc.

Alyce offers various optic options to meet different requirements for office, education, retail lighting etc. Thanks to its modular design,

it significantly saves the costs on installation, maintenance and stock ensuring sustainability, which helps our

clients to be more competitive with such innovative design and additional value.

ALYCE MODULE
Zhaga Standard LED Module

003



EOS ALYCE
Modular Panel Light

017

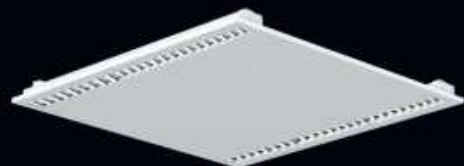

HERA ALYCE
Slim Modular Pendant Light

028



KEY ALYCE
Wide Modular Pendant Light

040



ARES ALYCE
Modular Linear Recessed Light

051



TINO ALYCE
Ceiling Customized
Modular Recessed Light

060



TAK ALYCE
Universal Intrack driver

073



FILI ALYCE
Modular Floor Standing Light

082



CONTENTS

HERA ALYCE



ARES ALYCE



TAK ALYCE



EOS ALYCE



TINO ALYCE



KEY ALYCE



FILI ALYCE



ALYCE FAMILY

- ALYCE MODULE LUMINAIRES

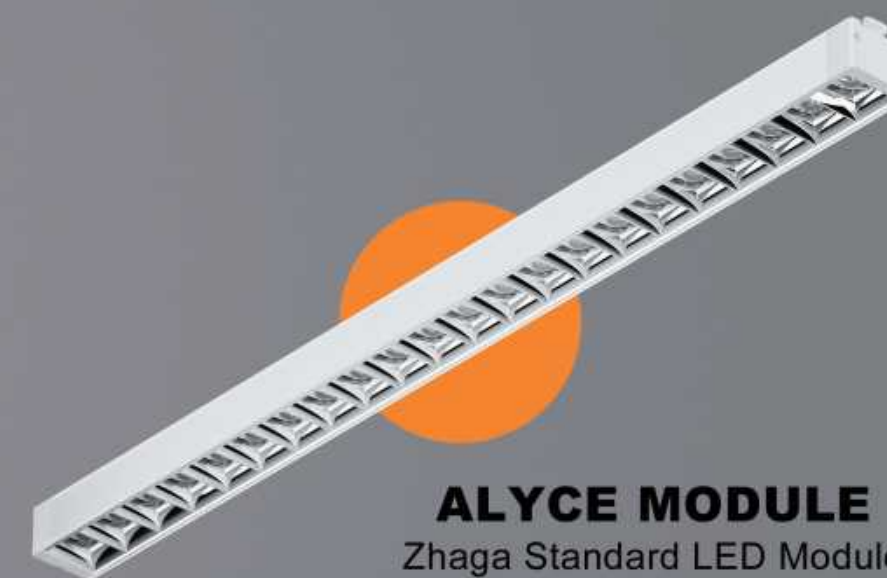

ALYCE MODULE
Zhaga Standard LED Module

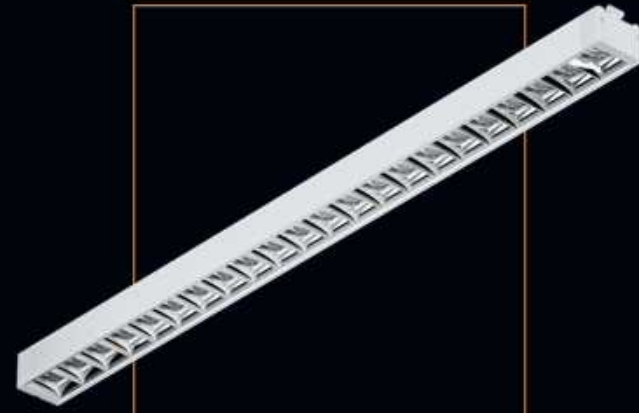

ALYCE MODULE

Zhaga Standard LED Module

ALYCE MODULE is a future trend design for luminaires by offering features of standardization, modularization, sustainability. It was designed according to Zhaga standard on mechanical, photometric, electrical, thermal, control interface. The Zhaga Consortium is a global lighting-industry organization that aims to standardize components of LED luminaires, including LED light engines, LED modules, LED arrays, holders, electronic control gear (LED drivers) and connectivity fit systems. Alyce module opens up a wide range in the luminaires design for panel light, pendant light, recessed light, floor light, track light etc. Alyce offers various optic options to meet different requirements for office, education, retail lighting etc. Thanks to its modular design, it significantly saves the costs on installation, maintenance and stock ensuring sustainability, which helps our clients to be more competitive with such innovative design and additional value.

Size

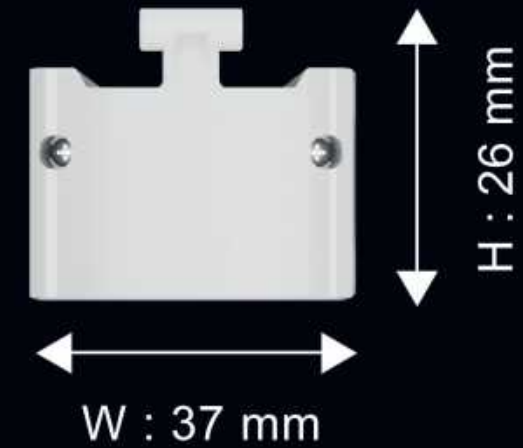

L: 564 / 864 / 1164 / 1464 mm

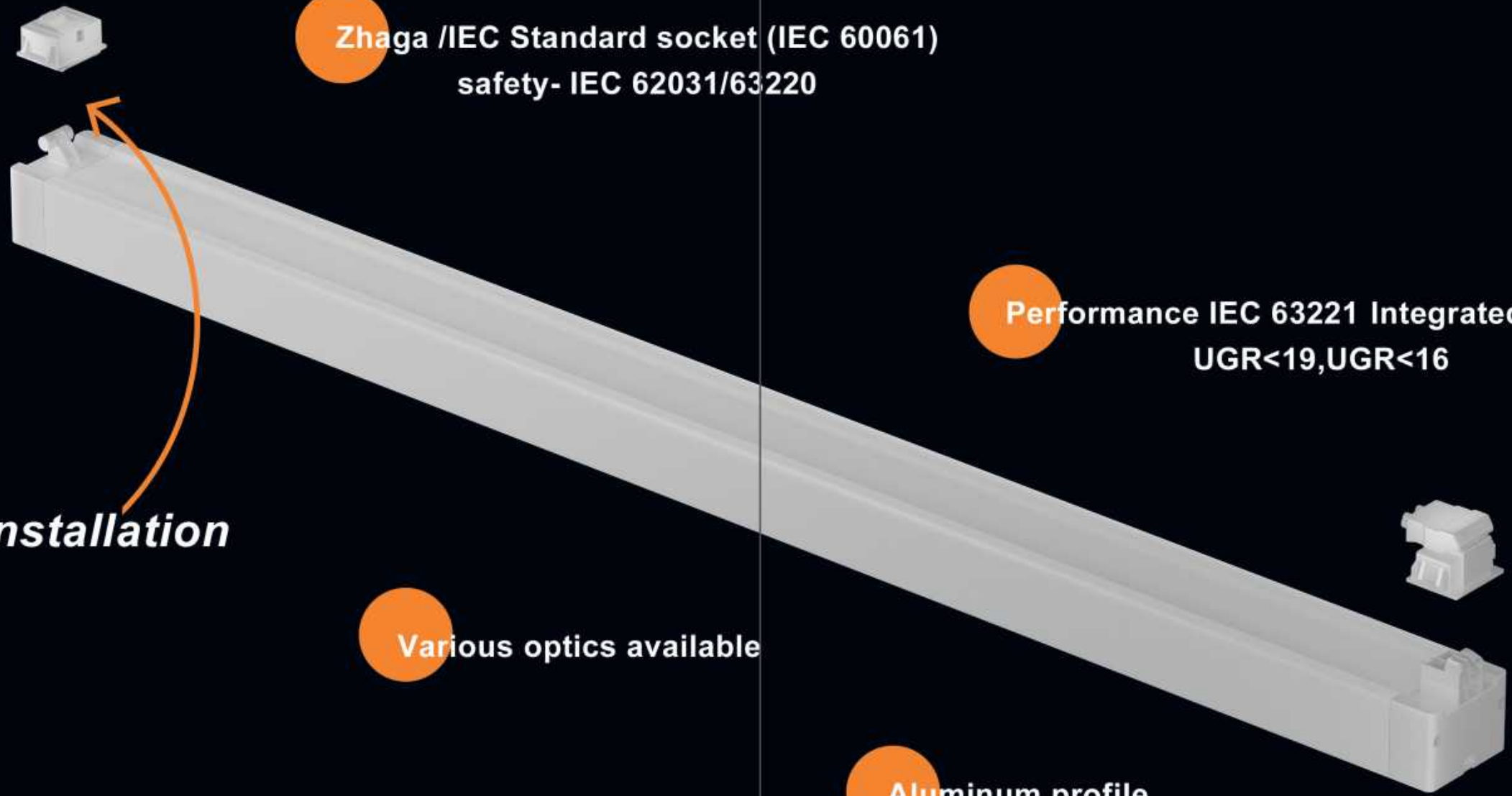

Zhaga /IEC Standard socket (IEC 60061)
safety- IEC 62031/63220

Performance IEC 63221 Integrated optics
UGR<19,UGR<16

Click fit installation

Various optics available

Aluminum profile



ALYCE MODULE

Zhaga Standard LED Module

CCT Adjustable

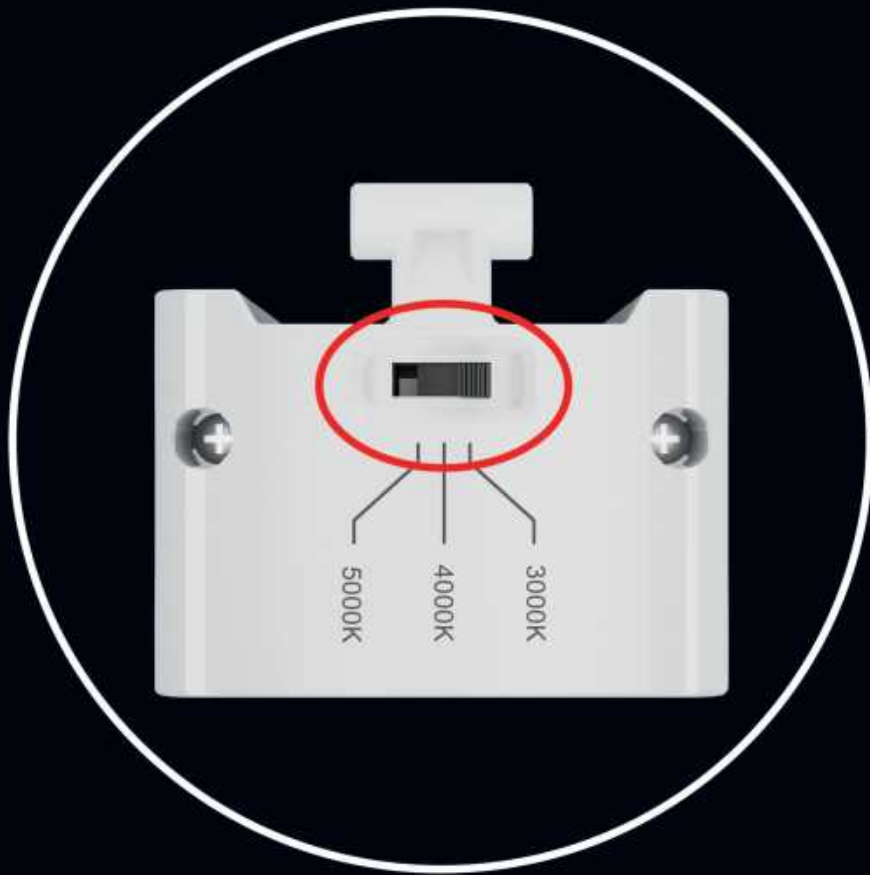

ALYCE MODULE
Zhaga Standard LED Module

ALYCE MODULE

Zhaga Standard LED Module

EOS ALYCE

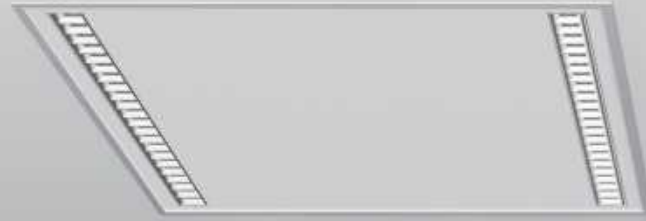

ALYCE MODULE

Zhaga Standard LED Module

-
HERA ALYCE



TRICCO
Innovate Your Light

ALYCE MODULE

Zhaga Standard LED Module

-
KEY ALYCE



TRICCO
Innovate Your Light

ALYCE MODULE

Zhaga Standard LED Module

-
ARES ALYCE



TRICCO
Innovate Your Light

ALYCE MODULE

Zhaga Standard LED Module

TINO ALYCE



TRICCO
Innovate Your Light

ALYCE MODULE

Zhaga Standard LED Module

-
TAK ALYCE



ALYCE MODULE

Zhaga Standard LED Module

FILI ALYCE





Tel:+86-752-5559317

Fax:+86-752-5559357

Email:info@trico-led.com

Website:www.trico-led.com