



DREAMLINE

LED trunking system



DREAMLINE

LED trunking system

Tool-free installation

High efficiency

Various optics

Dreamline is an efficient, flexible and versatile

linear light system providing lighting solution for various applications of industrial, commercial, office etc. It provides many lighting options with various luminaire elements, optics, functional modules to meet different lighting requirements. It saves time and cost due to its extremely easy and tool less installation and maintainance design.

DREAMLINE

LED trunking system

Dreamline is an efficient, flexible and versatile linear light system providing lighting solution for various applications of industrial, commercial, office etc. It provides many lighting options with various luminaire elements, optics, functional modules to meet different lighting requirements. It saves time and cost due to its extremely easy and tool less installation and maintainance design.

Size

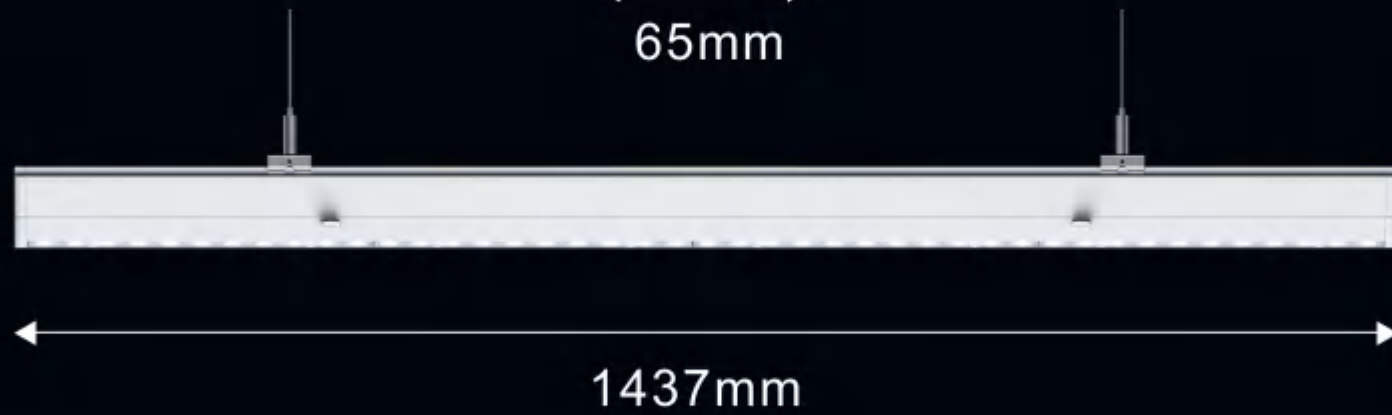
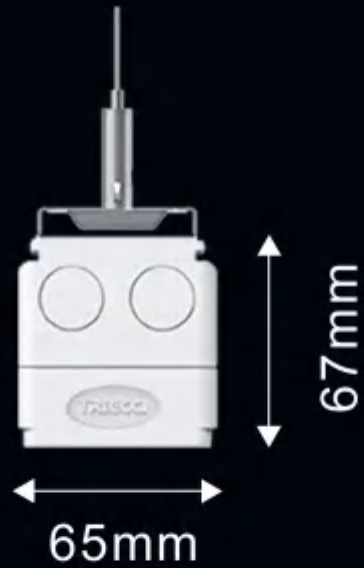

DREAMLINE

LED trunking system



02

Track module

Standard 3 phase track rail integrated
can be installed with track spot light
for accent lighting



04

Sensor module

daylight harvest
motion detection
infrared detection



05

Other functional module

CCTV module
EXIT light module
socket module
...

01

Luminaire

Various optics
DALI or 1-10V dimming
Battery emergency
emergency for centre battery system

03

Blank cover module

PC or aluminum version
installed at the position
without luminaire

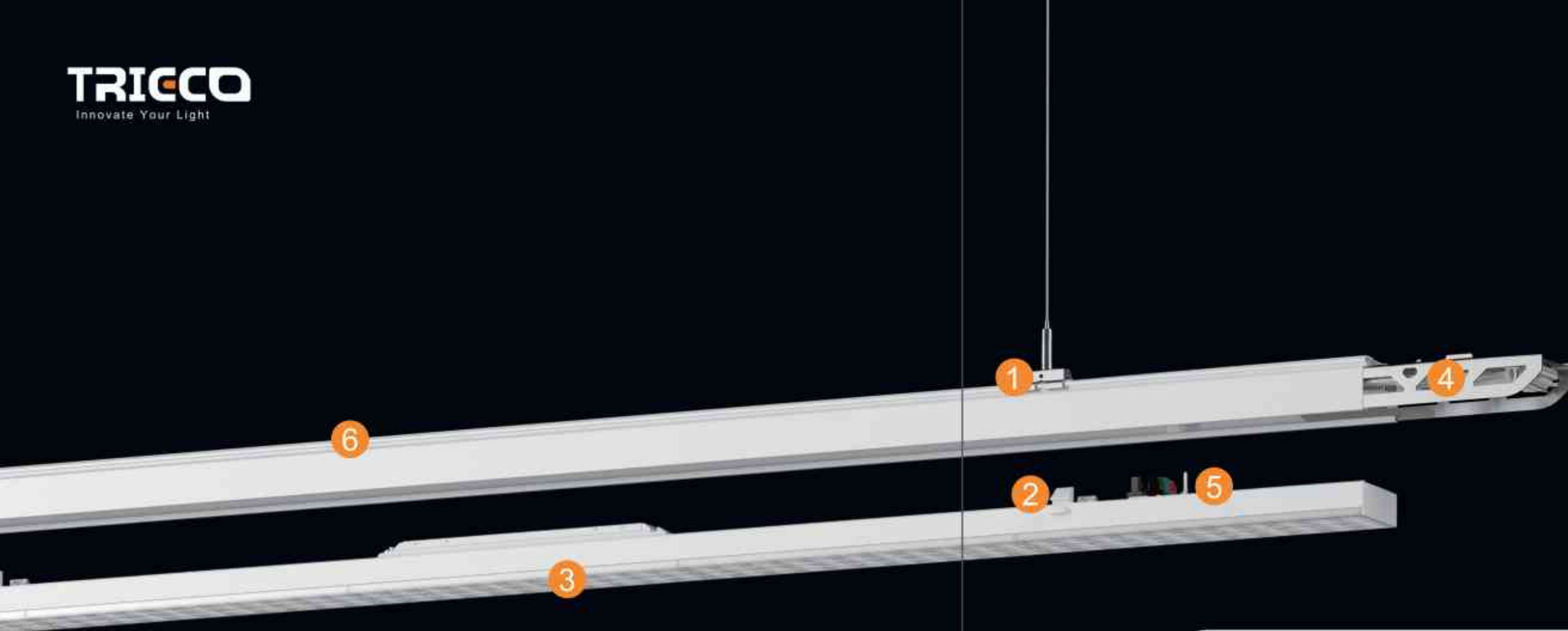

DREAMLINE

LED trunking system

Dreamline is an efficient, flexible and versatile linear light system providing lighting solution for various applications of industrial, commercial, office etc. It provides many lighting options with various luminaire elements, optics, functional modules to meet different lighting requirements. It saves time and cost due to its extremely easy and tool less installation and maintainance design.

An innovative EYE-Protection Panel

- ① Mounting kits
- ② Double click bracket
- ③ Luminaire with various optics
- ④ Pre assembled connecting board
- ⑤ Plug for electrical contact to main power
- ⑥ Pre wired 2.5mm² cable with VDE approved

Beam angle



DREAMLINE

LED trunking system

INNOVATIVE OPTICS DESIGN
FOR LOWEST LIGHT LOSS AND
OPTIMUM EFFICIENCY.



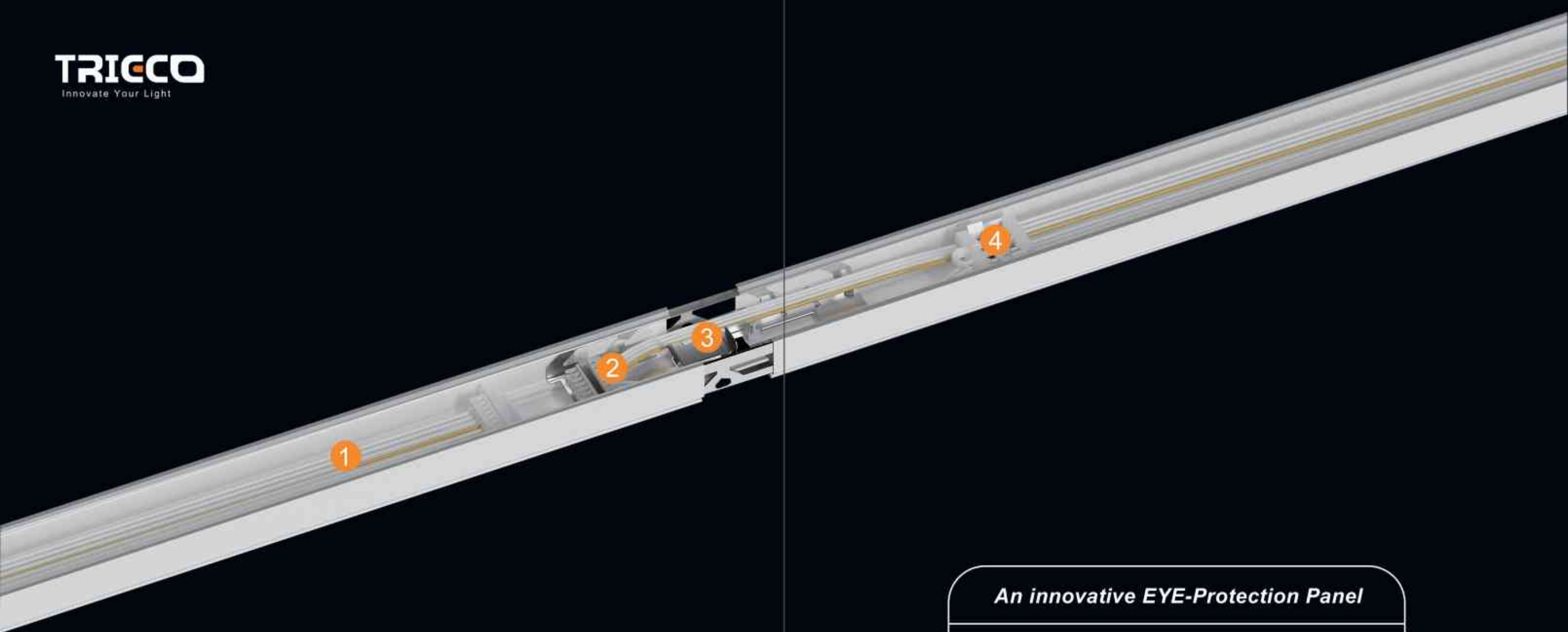

DREAMLINE

LED trunking system

Dreamline is an efficient, flexible and versatile linear light system providing lighting solution for various applications of industrial, commercial, office etc. It provides many lighting options with various luminaire elements, optics, functional modules to meet different lighting requirements. It saves time and cost due to its extremely easy and tool less installation and maintainance design.

An innovative EYE-Protection Panel

- ① 5/8/12 cables
- ② Plug in connector
- ③ Lockable connection design
- ④ Socket connecting to the plug on module

MORE ENERGY EFFICIENT, INNOVATIVE DIP SWITCH DESIGN INTEGRATED

New generation luminaire for Dreamline trunking light system improved with higher lumen efficiency. 8 different power from 25-75W selectable thanks to the dip switch design.

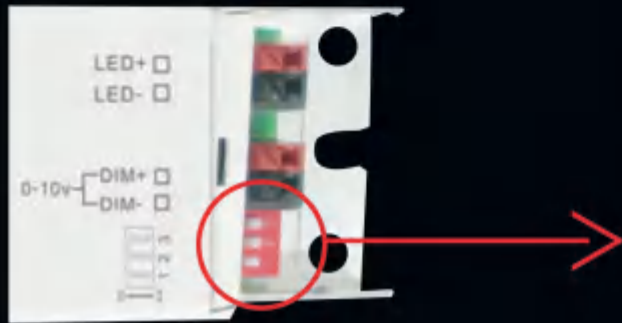

P1	P2	Irated	1	2	3
75W	69W	440mA	-	-	-
65W	60W	380mA	NO	-	-
55W	50W	320mA	-	NO	-
45W	41W	270mA	NO	NO	-
40W	37W	240mA	-	-	NO
35W	32W	210mA	NO	-	NO
30W	27W	180mA	-	NO	NO
25W	22W	140mA	NO	NO	NO

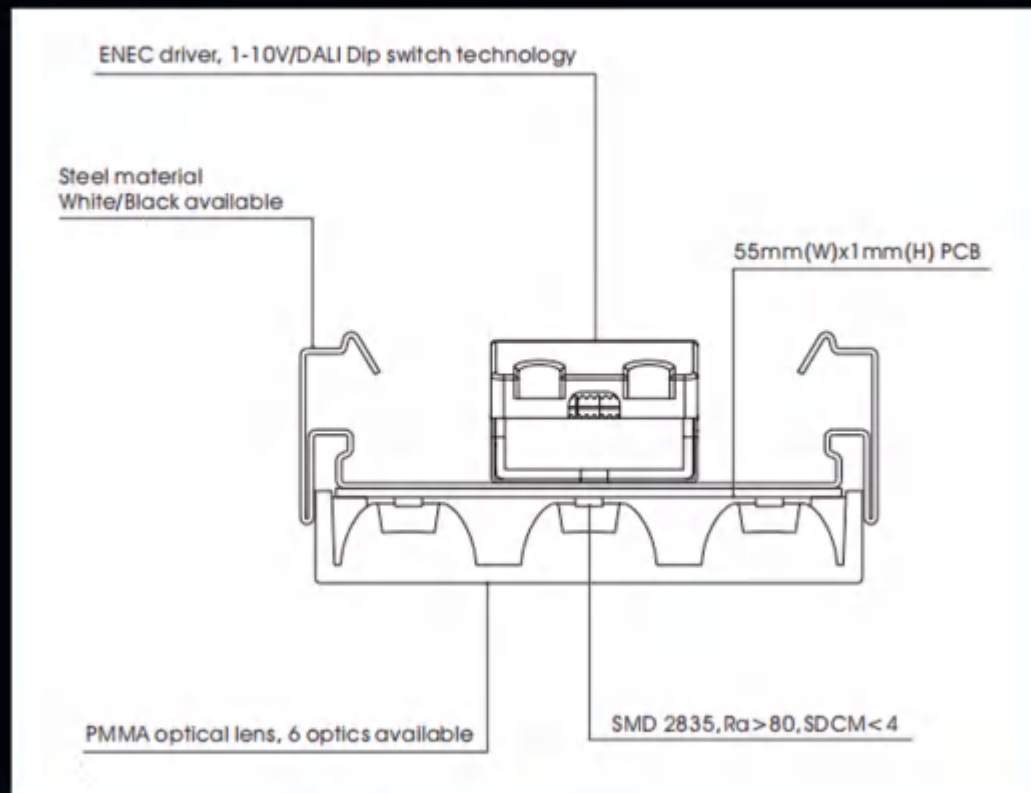

DREAMLINE
LED trunking system

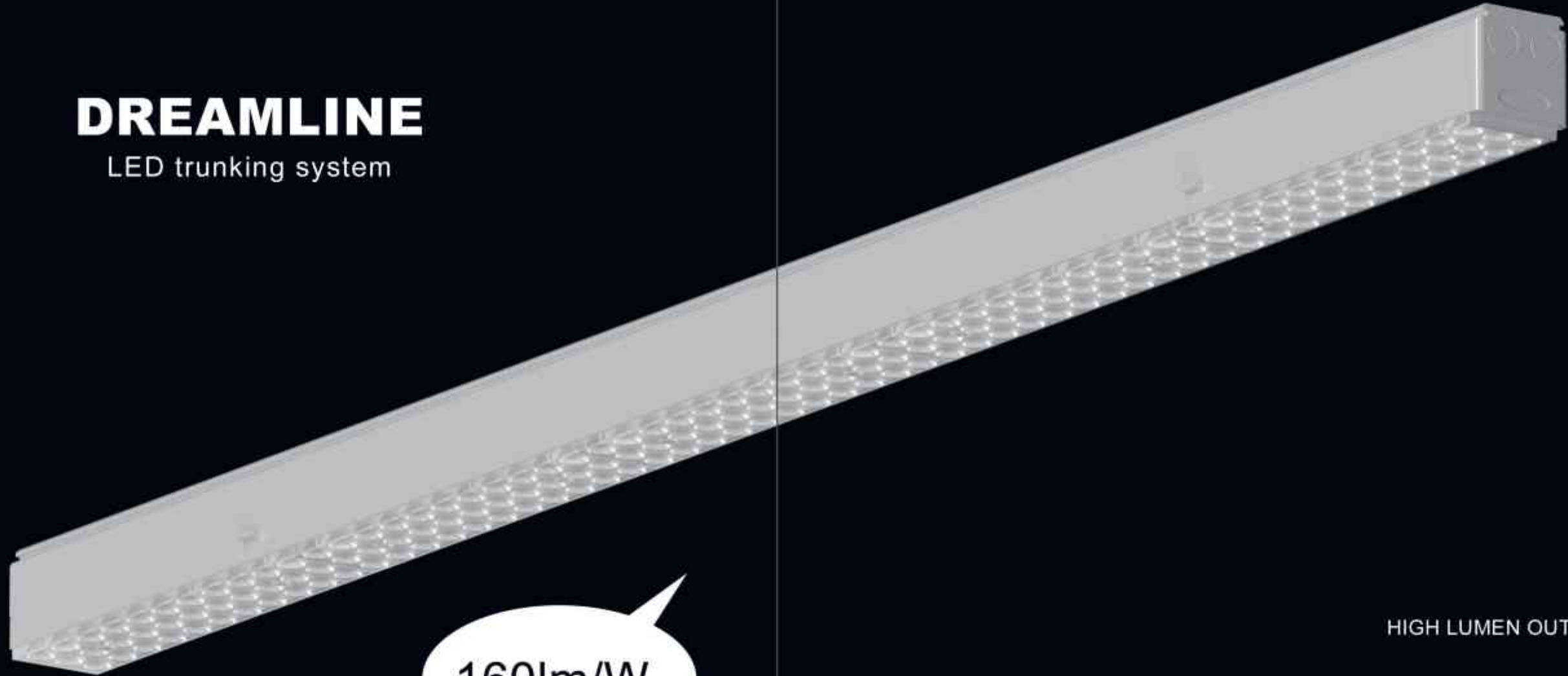

160lm/W

HIGH LUMEN OUTPUT

Dreamline allows you to use less luminaires to meet your lux requirement. Investment will be paid off in shorter time.

Dreamline provides high colour rendering index > Ra 80. CLO (constant light output) technology incorporated in Dreamline to maintain initial luminous flux through out the whole life time.



Track module

Model No: T03A15TS

Length: 1437mm

With 700mm ENEC approved

Track for 1437mm trunk



Sensor module

Model No: T03A150SN

Length: 1437mm

Detect distance:10M Detected

angle:120° Need 8 wires trunk



Emergency module

Model No: T03A15L75SRSE/T03

A15L75SDSE

Length: 1437mm

Automatic Battery Status Detect 3h

Emergency Time @ 10w Li-battery Inside



Emergency light module

Model No: T03AEML

Length: 1437mm

Extra functional modules like track module, blank cover module, emergency module socket module perfectly integrated into Dreamline system.

SAVING 70% INSTALLATION TIME & COSTS



Tool-free installation

Dreamline requires minimal wiring joints compared to the installation with individual luminaires, which can dramatically reduce labour costs and efforts.



Individual Luminaires

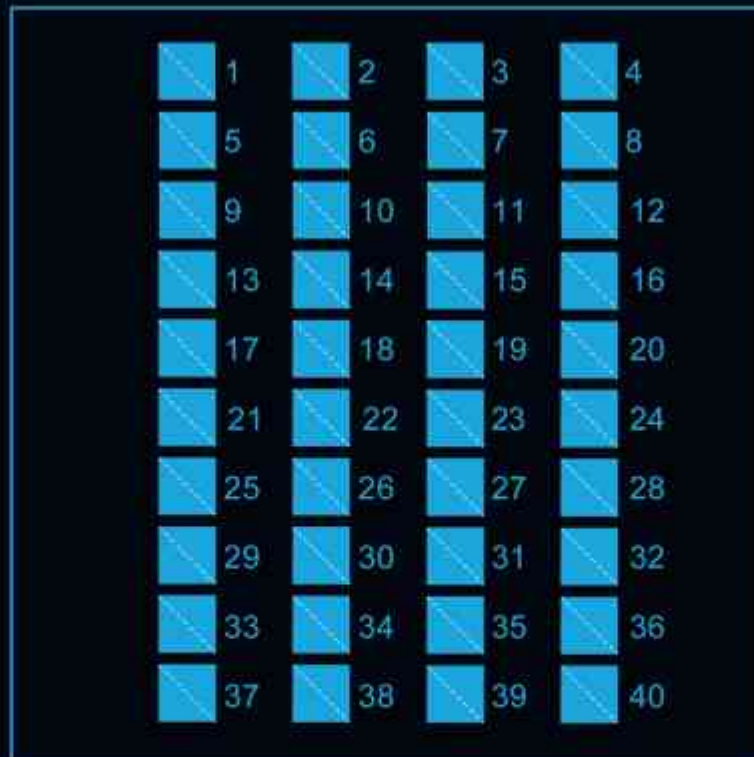

Luminaires:40

Wiring points **40**

DREAMLINE

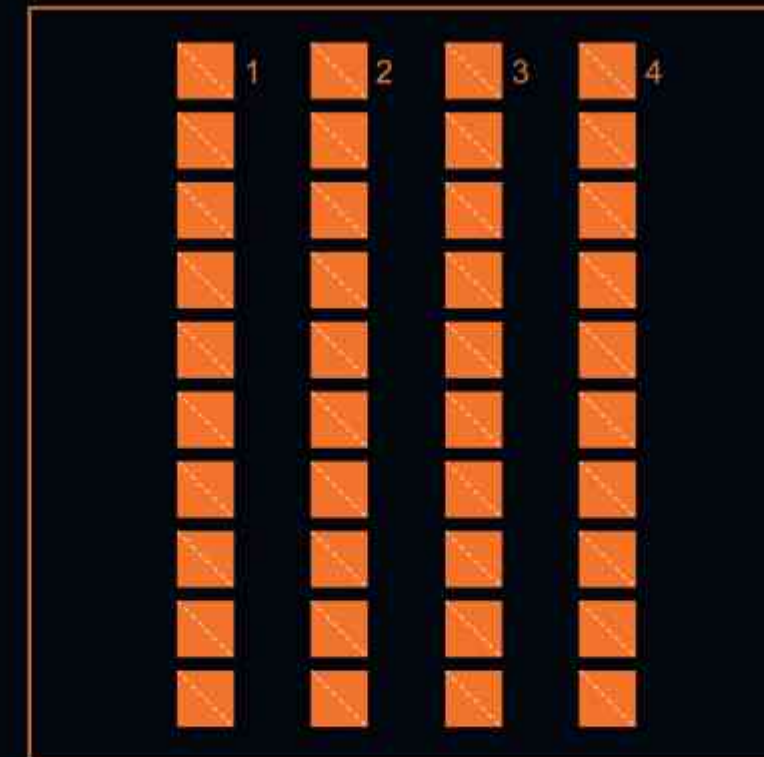

Luminaires:40

Wiring points **4**

Trunking Rail

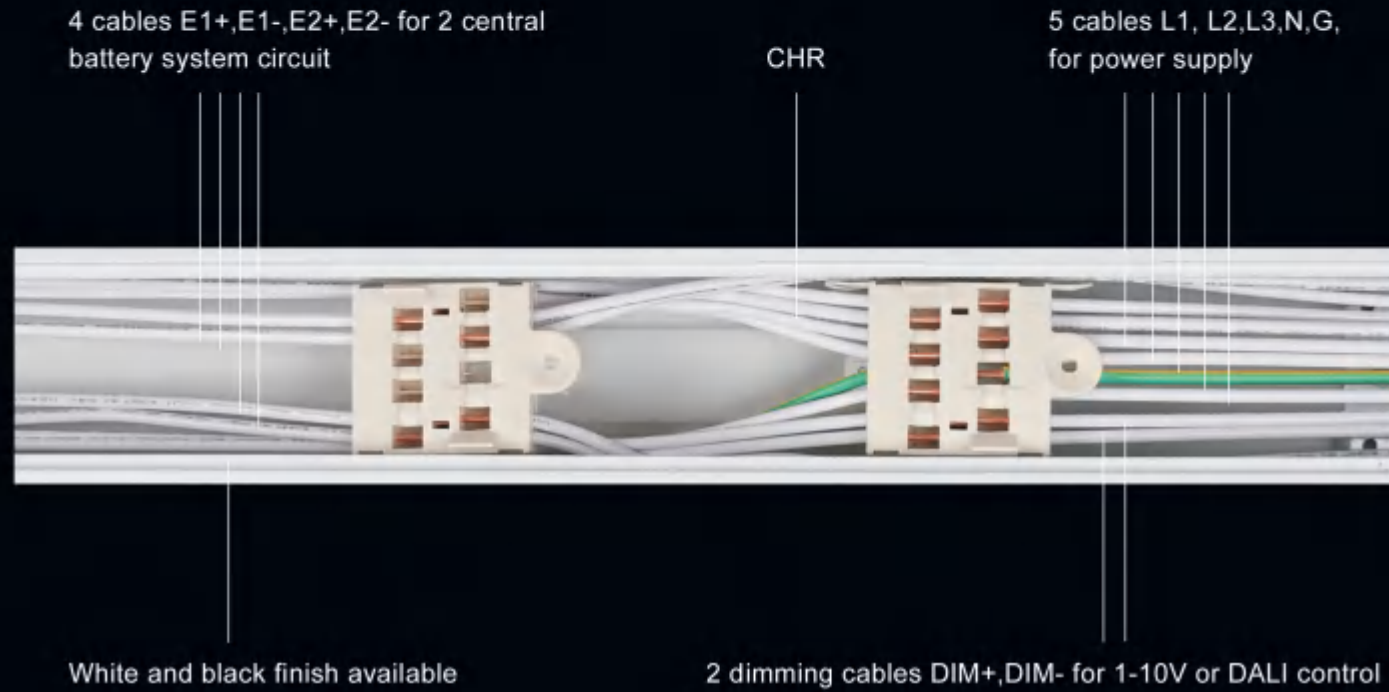

5-pole



8-pole

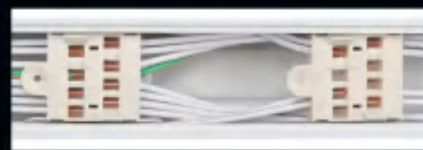

12-pole

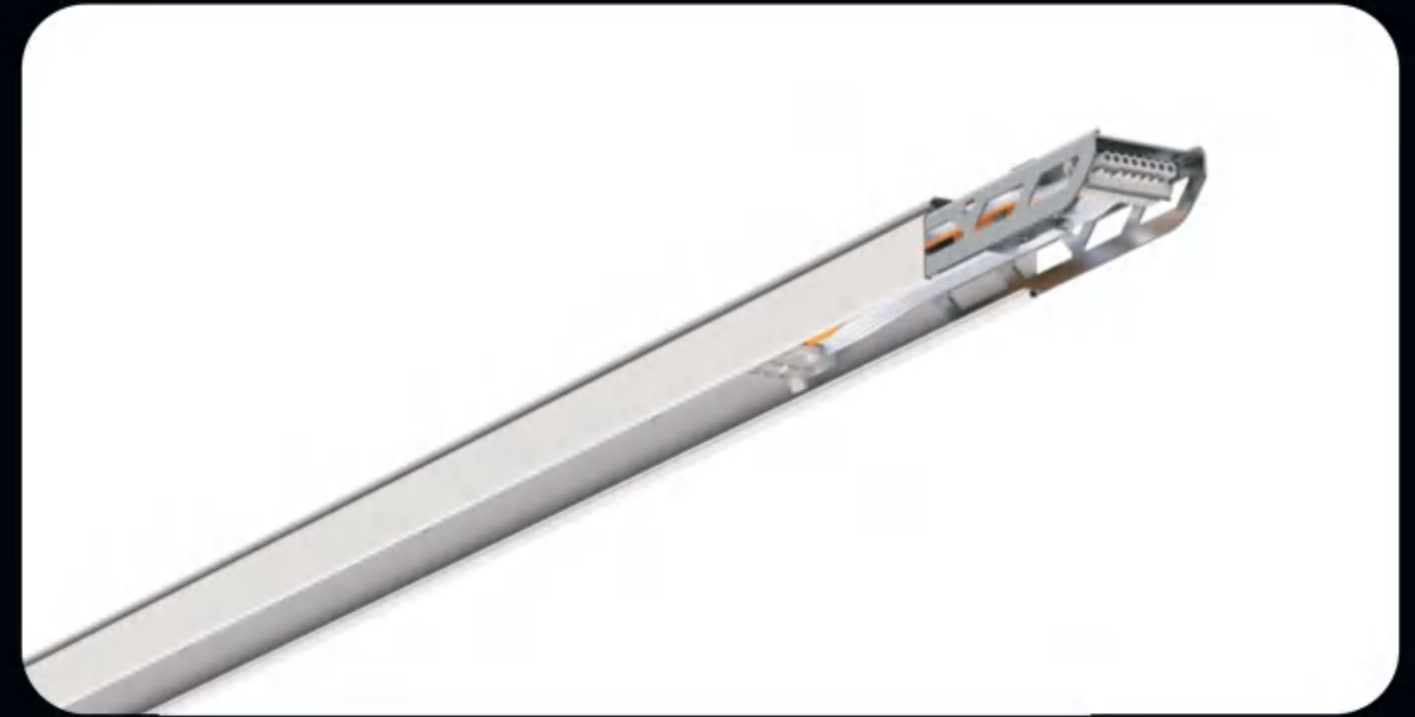
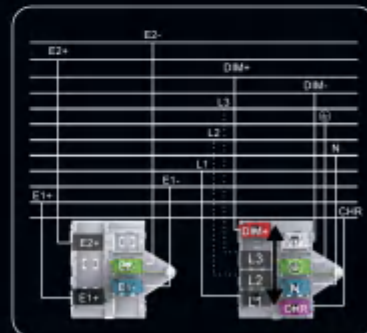
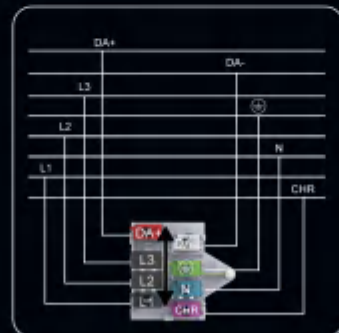
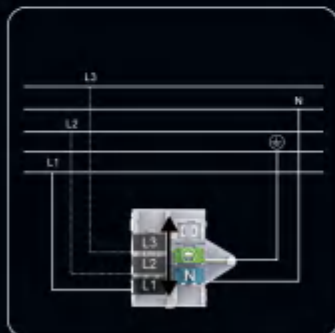

5 Wires

Type	Description	L	W	H
T03B1505	5 wires	1437	65	45
T03B3005	5 wires	2870	65	45

8 Wires

Type	Description	L	W	H
T03B1505	5 wires	1437	65	45
T03B3005	5 wires	2870	65	45

12 Wires

Type	Description	L	W	H
T03B1505	5 wires	1437	65	45
T03B3005	5 wires	2870	65	45

ACCESSORY



Chain suspension kit



Steel cable suspension kit



Surface mounting kit

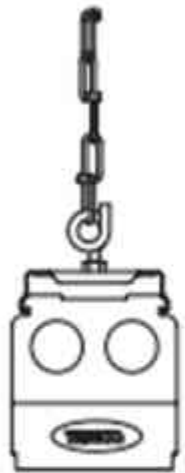
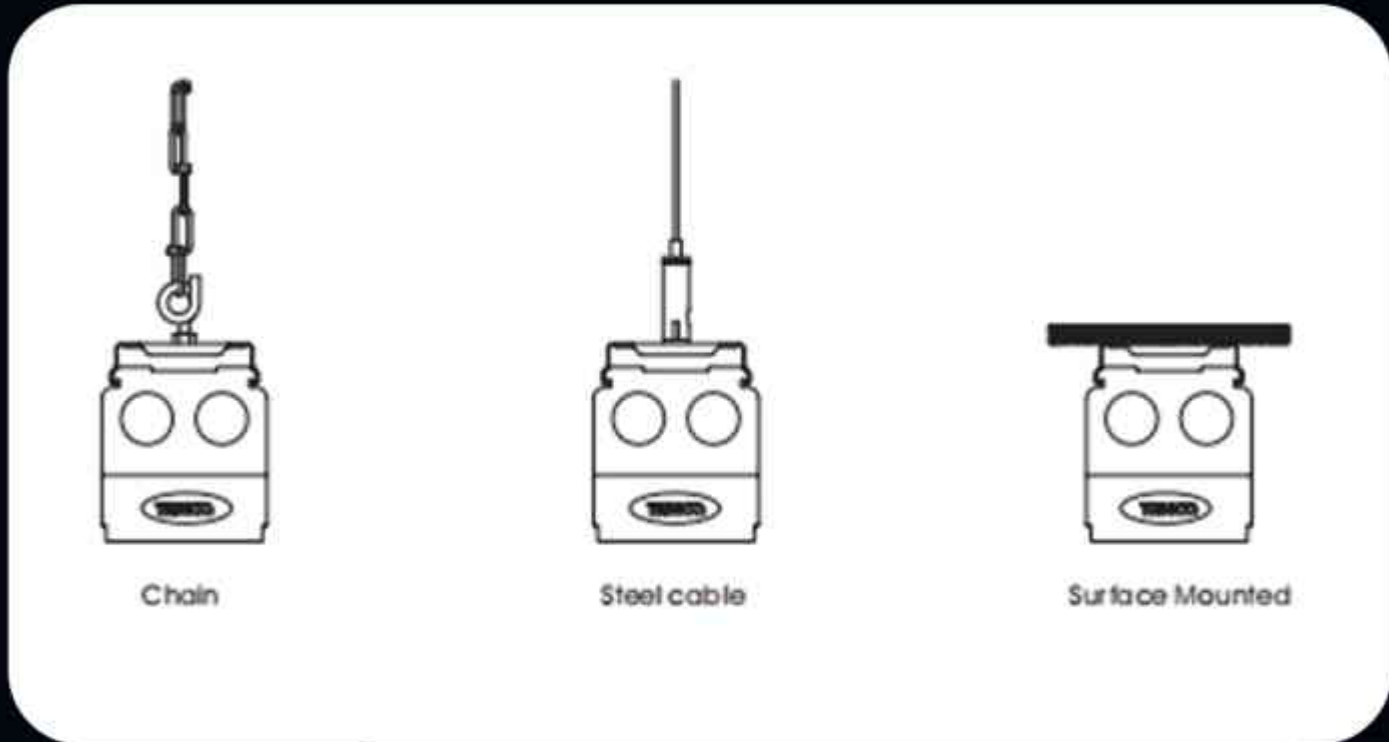

Chain

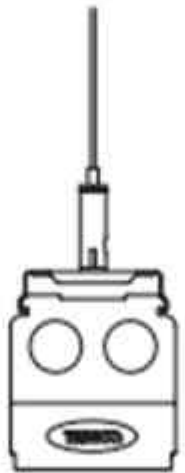

Steel cable



Surface Mounted

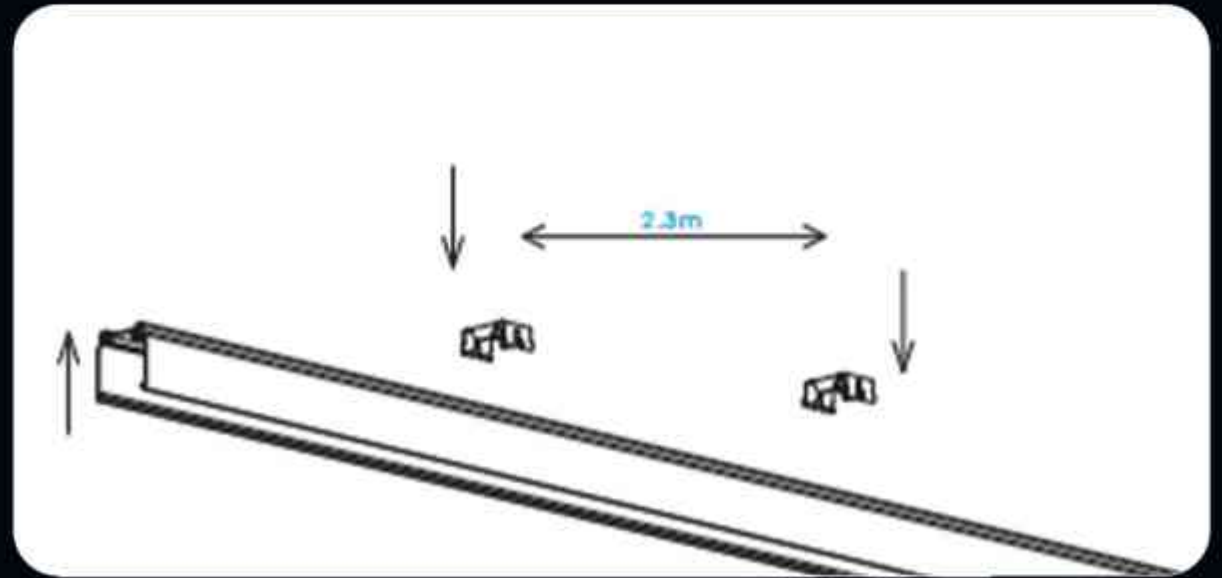
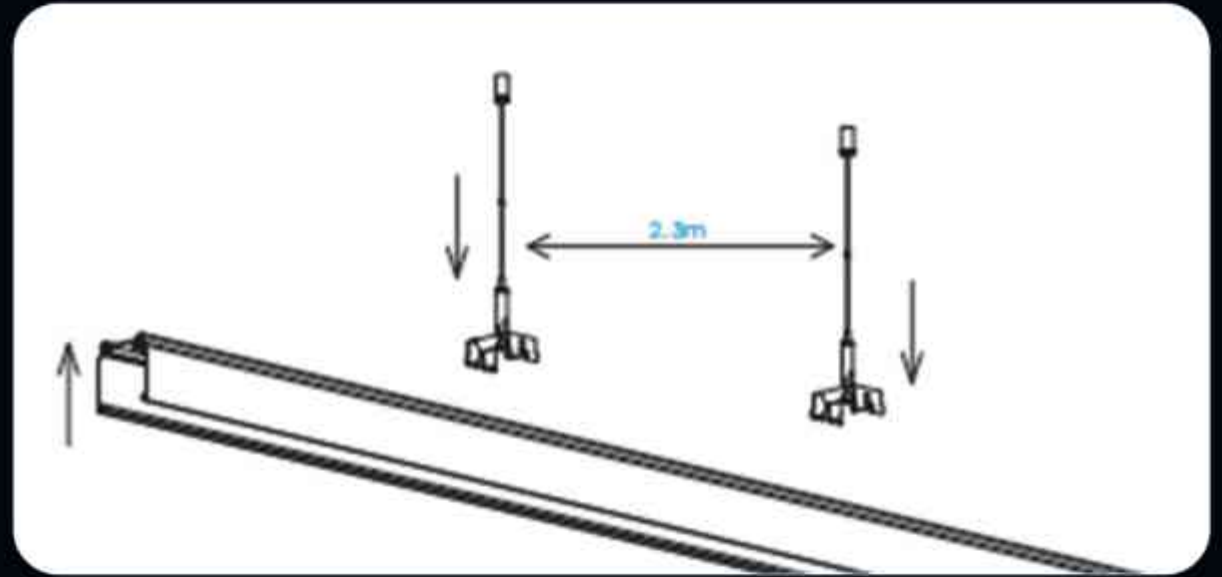
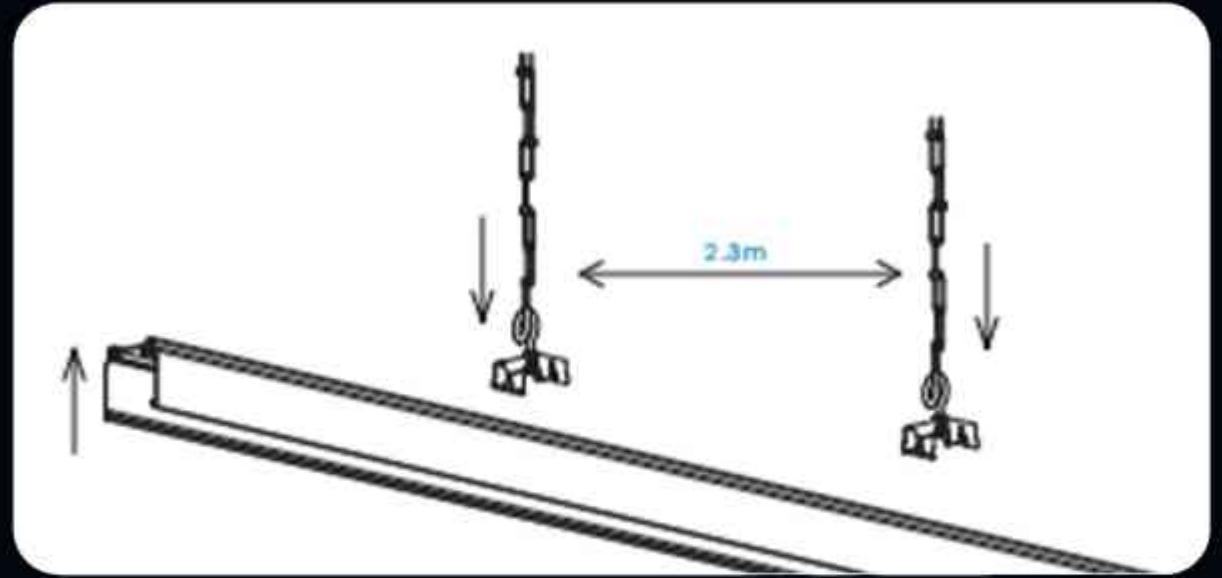

ACCESSORY



Surface ceiling fixing

Model No : DMA001

Kits Size : 53*36*15mm

Thickness : 0.5mm spring steel

Steel cable suspension

Model No : DMA002

Steel cable suspension kits

Length : 2 meter



Chain suspension

Model No:DMA003

Chain suspension kits

Length: 2 meter

Input cable protector

Model No: DMA012S

IP 67 Waterproof joint

Material: Iron nickel plating



Chain suspension

Model No:DMA003

Chain suspension kits

Length: 2 meter



EFFICIENCY COMPARISON

Application Supermarket

	T8 2x58W(Fluorescent)	Dreamline(LED)
Luminous flux	8364 lm	8800 lm
Power consumption	123W	55W
Luminous efficacy	68 lm/W	160 lm/W
Total power consumption	28905W	11880W
Power factor	0.9	0.95
Direct/in direct emitting	100%direct	100%direct
Optical type	diffuser	led lens
Number of luminaire	235	216

60%

less energy

10%

fewer luminaires



EFFICIENCY COMPARISON

Application Supermarket

	Metal halide	Dreamline(LED)
Luminous flux	10500 lm	11625 lm
Power consumption	150W	75W
Luminous efficacy	70 lm/W	155 lm/W
Total power consumption	174000W	74250W
Power factor	0.8	0.95
Direct/in direct emitting	indirect	100%direct
Optical type	reflect	led lens
Number of luminaire	1160	990

58%

less energy

10%

fewer luminaires



EFFICIENCY COMPARISON

Application Supermarket

	Metal halide	Dreamline(LED)
Luminous flux	8364 lm	8800 lm
Power consumption	115W	55W
Luminous efficacy	68 lm/W	160 lm/W
Total power consumption	21260W	9240W
Power factor	0.9	0.95
Direct/in direct emitting	100%direct	100%direct
Optical type	diffuser	led lens
Number of luminaire	118	168

57%

less energy

10%

fewer luminaires

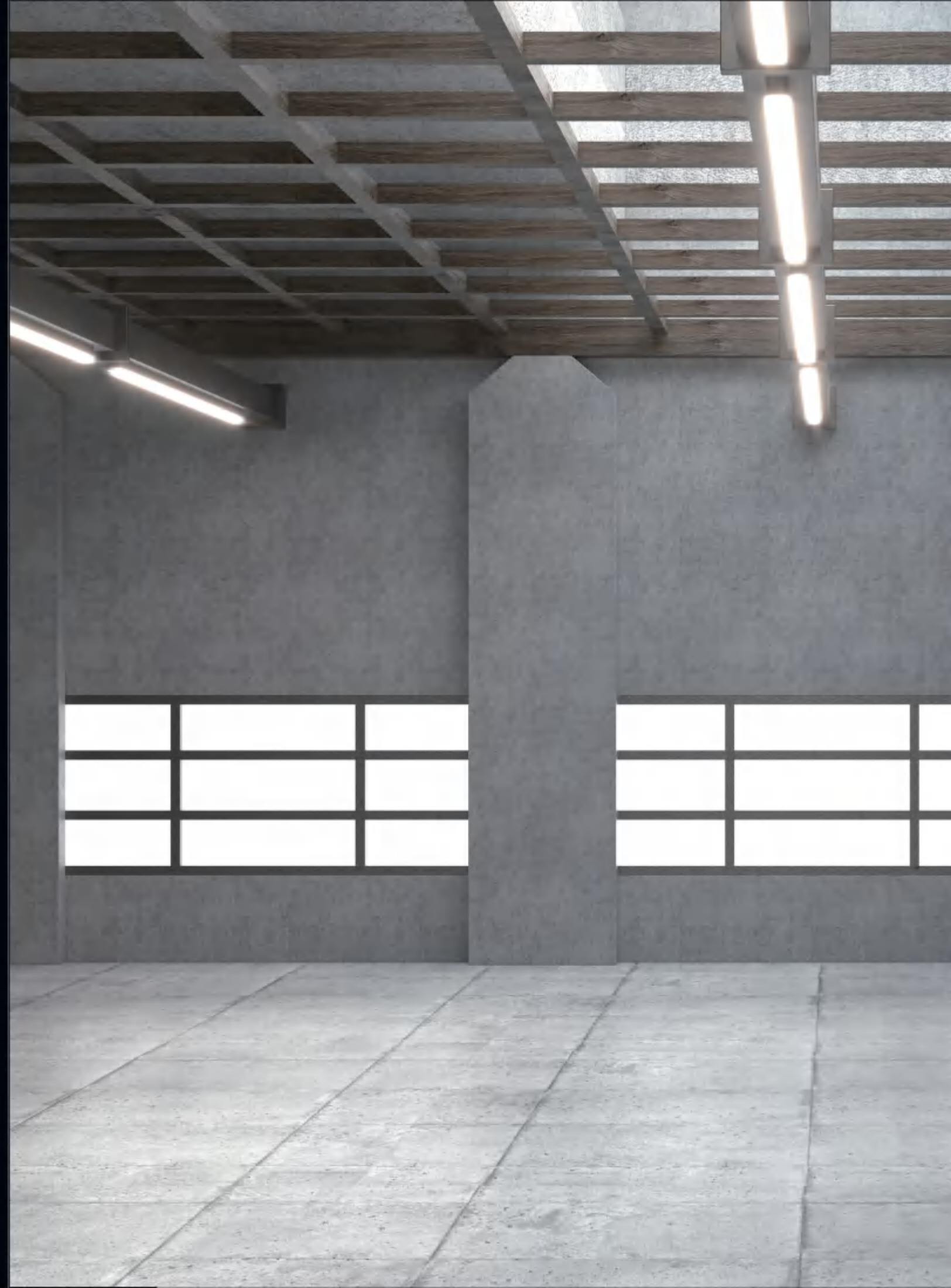

TRICCO
Innovate Your Light

DREAMLINE

LED trunking system



TRICCO
Innovate Your Light

DREAMLINE
LED trunking system





Tel:+86-752-5559317

Fax:+86-752-5559357

Email:info@trico-led.com

Website:www.trico-led.com